

## SiGe HBT GAIN BLOCK MMIC AMPLIFIER, DC - 5.0 GHz

### Typical Applications

The HMC481MP86 is an ideal RF/IF gain block & LO or PA driver for:

- Cellular / PCS / 3G
- Fixed Wireless & WLAN
- CATV, Cable Modem & DBS
- Microwave Radio & Test Equipment

### Functional Diagram

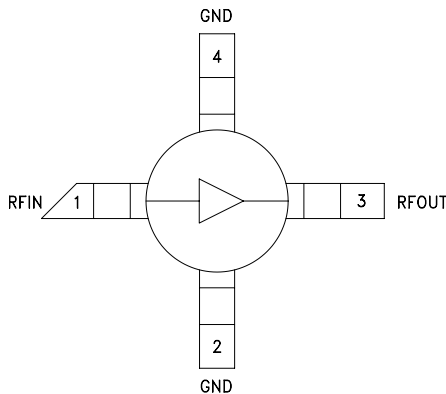

### Features

- P1dB Output Power: +19 dBm
- Gain: 20 dB
- Output IP3: +33 dBm
- Cascadable 50 Ohm I/Os
- Single Supply: +6V to +12V

### General Description

The HMC481MP86 is a SiGe Heterojunction Bipolar Transistor (HBT) Gain Block MMIC SMT amplifier covering DC to 5 GHz. This Micro-P packaged amplifier can be used as a cascadable 50 Ohm RF/IF gain stage as well as a LO or PA driver with up to +21 dBm output power. The HMC481MP86 offers 20 dB of gain with a +33 dBm output IP3 at 850 MHz while requiring only 74 mA from a single positive supply. The Darlington feedback pair used results in reduced sensitivity to normal process variations and excellent gain stability over temperature while requiring a minimal number of external bias components.

### Electrical Specifications, $V_s = 8.0\text{ V}$ , $R_{bias} = 39\text{ Ohm}$ , $T_A = +25^\circ\text{ C}$

Parameter		Min.	Typ.	Max.	Units
Gain	DC - 1.0 GHz	18.5	20.0		dB
	1.0 - 2.0 GHz	15.5	17.0		dB
	2.0 - 3.0 GHz	12.5	14.0		dB
	3.0 - 4.0 GHz	10.5	12.0		dB
	4.0 - 5.0 GHz	9.0	10.5		dB
Gain Variation Over Temperature	DC - 5.0 GHz		0.008	0.012	dB/ °C
Input Return Loss	DC - 1.0 GHz		13		dB
	1.0 - 5.0 GHz		17		dB
Output Return Loss	DC - 1.0 GHz		20		dB
	1.0 - 4.0 GHz		25		dB
	4.0 - 5.0 GHz		15		dB
Reverse Isolation	DC - 5.0 GHz		18		dB
Output Power for 1 dB Compression (P1dB)	0.5 - 1.0 GHz	16	20		dBm
	1.0 - 2.0 GHz	15	18		dBm
	2.0 - 3.0 GHz	14	17		dBm
	3.0 - 4.0 GHz	12	15		dBm
	4.0 - 5.0 GHz	9	12		dBm
Output Third Order Intercept (IP3) (Pout= 0 dBm per tone, 1 MHz spacing)	0.5 - 2.0 GHz		33		dBm
	2.0 - 3.0 GHz		31		dBm
	3.0 - 4.0 GHz		29		dBm
	4.0 - 5.0 GHz		26		dBm
Noise Figure	DC - 2.0 GHz		3.5		dB
	2.0 - 4.0 GHz		4.0		dB
	4.0 - 5.0 GHz		4.5		dB
Supply Current (Icq)			74		mA

Note: Data taken with broadband bias tee on device output.

## SiGe HBT GAIN BLOCK MMIC AMPLIFIER, DC - 5.0 GHz

**Broadband Gain & Return Loss**

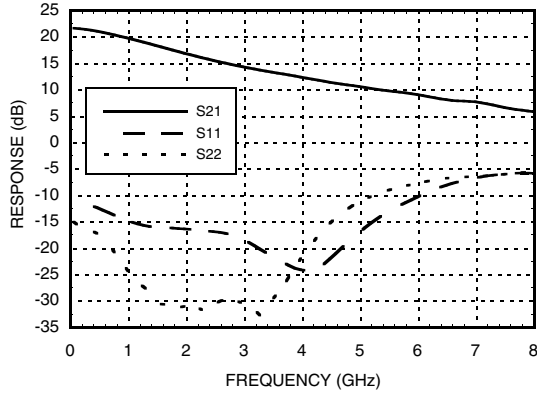

**Gain vs. Temperature**

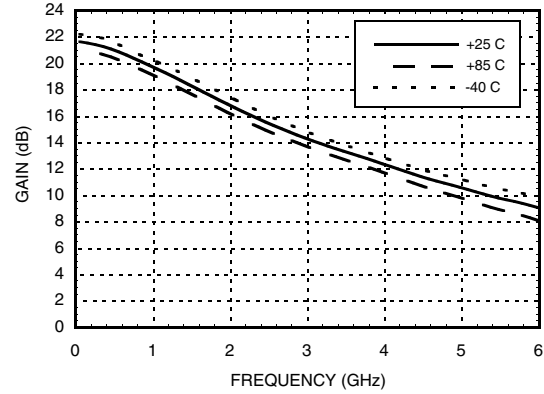

**Input Return Loss vs. Temperature**

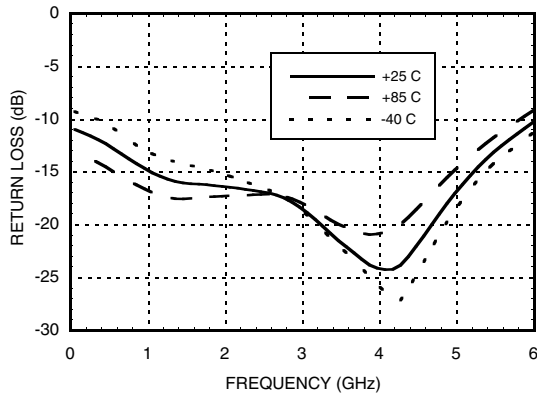

**Output Return Loss vs. Temperature**

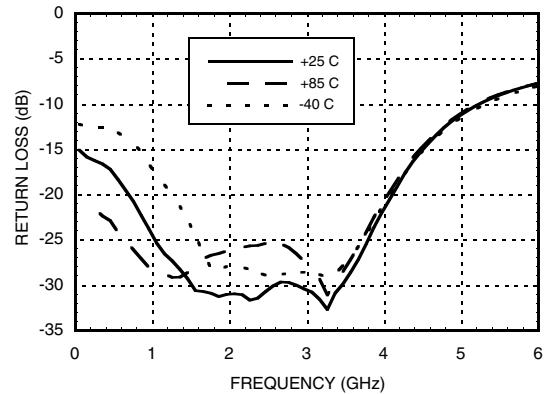

**Reverse Isolation vs. Temperature**

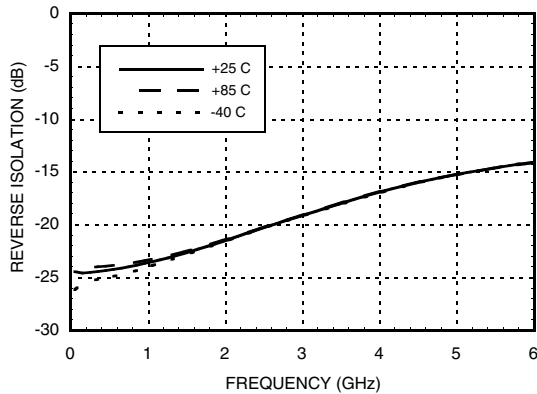

**Noise Figure vs. Temperature**

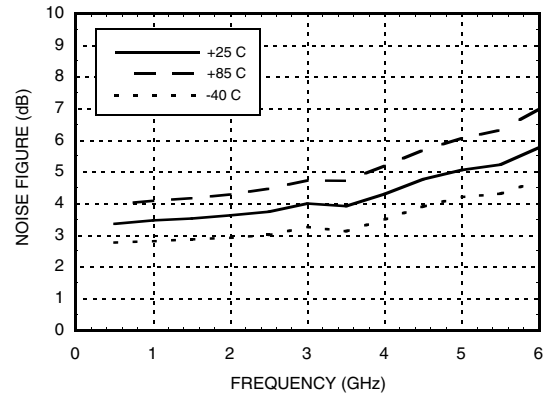

## SiGe HBT GAIN BLOCK MMIC AMPLIFIER, DC - 5.0 GHz

**P1dB vs. Temperature**

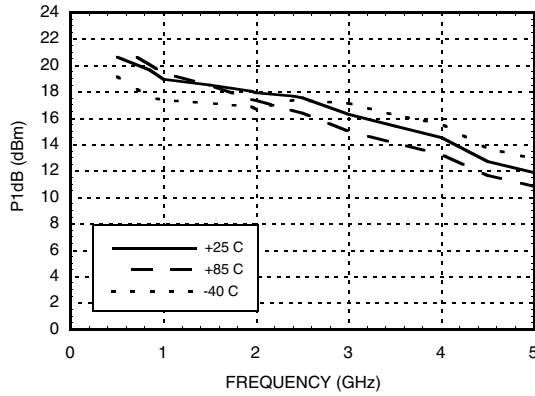

**Psat vs. Temperature**

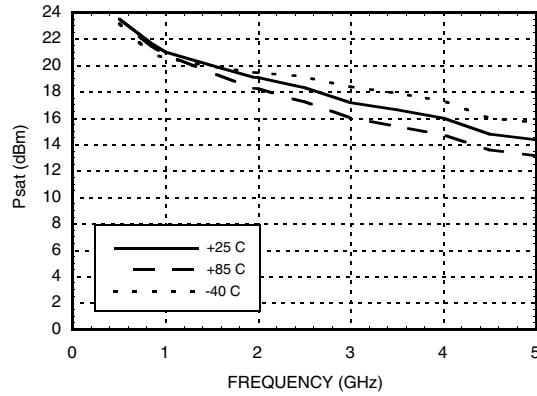

**Output IP3 vs. Temperature**

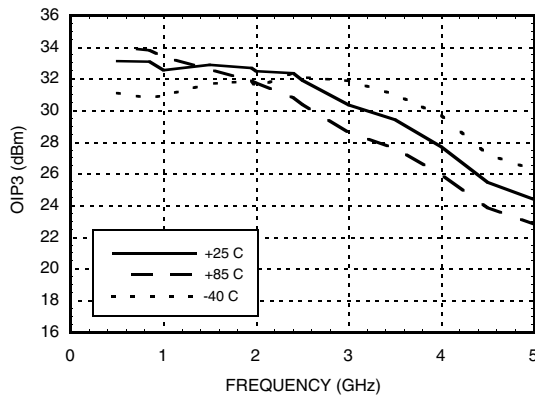

**Gain, Power & OIP3 vs. Supply Voltage for Constant Id= 74 mA @ 850 MHz**

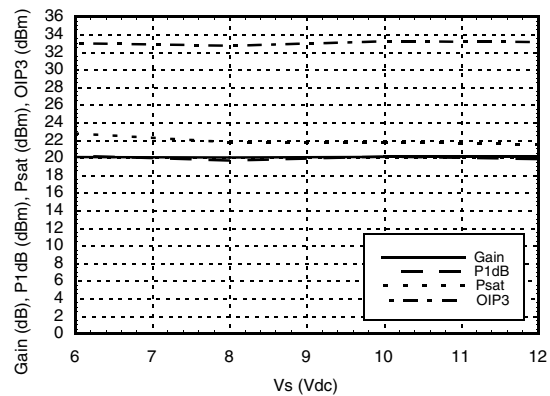

**Vcc vs. Icc Over Temperature for Fixed Vs= 8V, RBIAS= 39 Ohms**

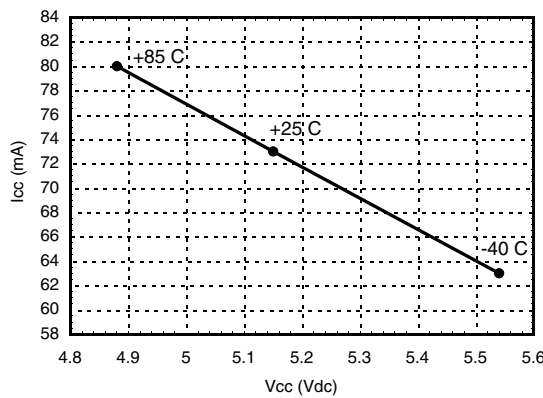

## SiGe HBT GAIN BLOCK MMIC AMPLIFIER, DC - 5.0 GHz

### Absolute Maximum Ratings

Collector Bias Voltage (Vcc)	+6.0 Vdc
Collector Bias Current (Icc)	100 mA
RF Input Power (RFIn)(Vcc = +5.15 Vdc)	+17 dBm
Junction Temperature	150 °C
Continuous Pdiss (T = 85 °C) (derate 11.6 mW/°C above 85 °C)	0.753 W
Thermal Resistance (junction to lead)	86.3 °C/W
Storage Temperature	-65 to +150 °C
Operating Temperature	-40 to +85 °C

### Outline Drawing

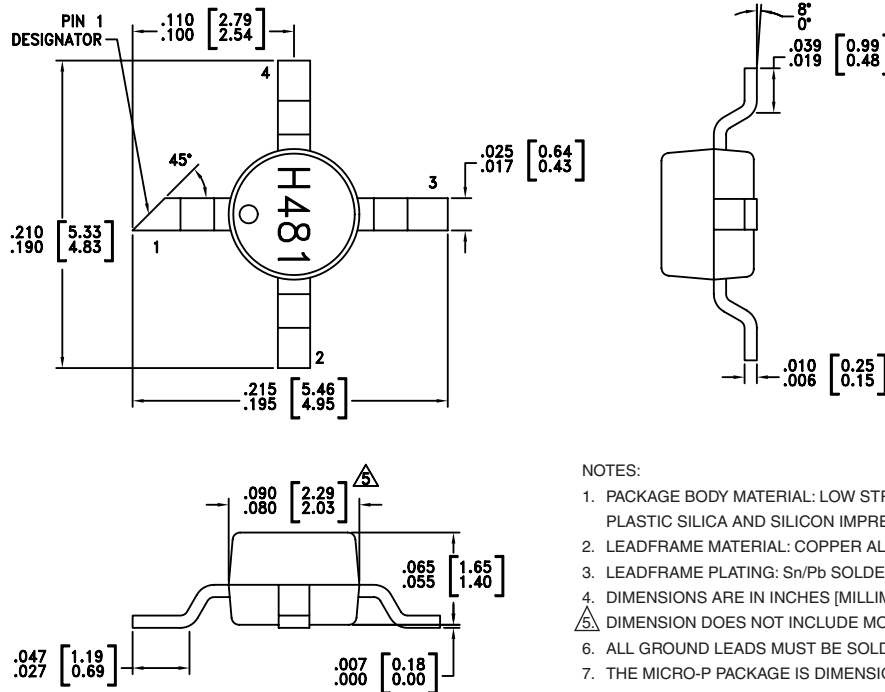

NOTES:

1. PACKAGE BODY MATERIAL: LOW STRESS INJECTION MOLDED PLASTIC SILICA AND SILICON IMPREGNATED.
2. LEADFRAME MATERIAL: COPPER ALLOY
3. LEADFRAME PLATING: Sn/Pb SOLDER
4. DIMENSIONS ARE IN INCHES [MILLIMETERS].
5. DIMENSION DOES NOT INCLUDE MOLDFLASH OF 0.15mm PER SIDE.
6. ALL GROUND LEADS MUST BE SOLDERED TO PCB RF GROUND.
7. THE MICRO-P PACKAGE IS DIMENSIONALLY COMPATIBLE WITH THE "MICRO-X PACKAGE"

## SiGe HBT GAIN BLOCK MMIC AMPLIFIER, DC - 5.0 GHz

### Pin Descriptions

Pin Number	Function	Description	Interface Schematic
1	RFIN	This pin is DC coupled. An off chip DC blocking capacitor is required.	
3	RFOUT	RF output and DC Bias (Vcc) for the output stage.	
2, 4	GND	These pins must be connected to RF/DC ground.	

### Application Circuit

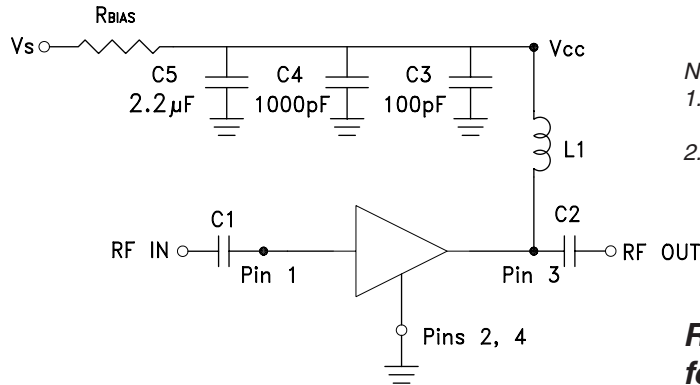

**Note:**

- External blocking capacitors are required on RFIN and RFOUT.
- RBIAS provides DC bias stability over temperature.

### Recommended Bias Resistor Values for $I_{cc} = 74 \text{ mA}$ , $R_{bias} = (V_s - V_{cc}) / I_{cc}$

Supply Voltage (Vs)	6V	8V	10V	12V
RBIAS VALUE	11 Ω	39 Ω	62 Ω	91 Ω
RBIAS POWER RATING	1/8 W	1/4 W	1/2 W	1 W

### Recommended Component Values for Key Application Frequencies

Component	Frequency (MHz)						
	50	900	1900	2200	2400	3500	5000
L1	270 nH	56 nH	18 nH	18 nH	15 nH	8.2 nH	6.8 nH
C1, C2	0.01 µF	100 pF	100 pF	100 pF	100 pF	100 pF	100 pF

## SiGe HBT GAIN BLOCK MMIC AMPLIFIER, DC - 5.0 GHz

### Evaluation PCB

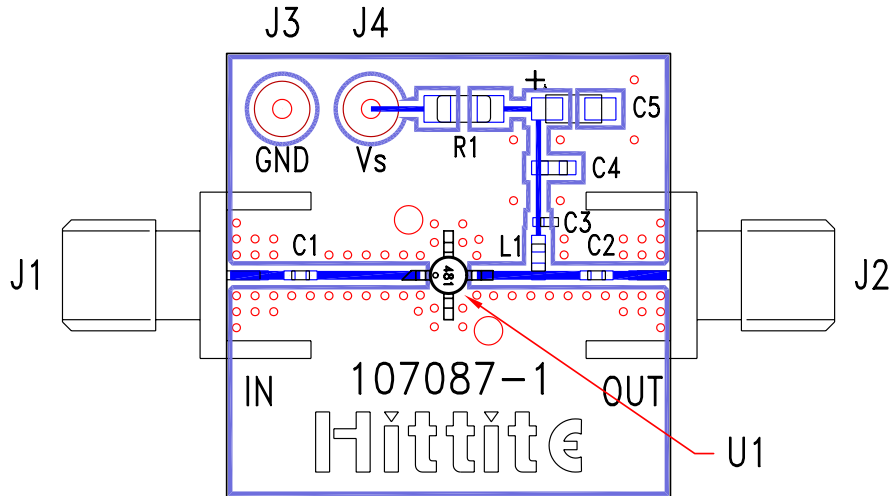

### List of Materials

Item	Description
J1 - J2	PC Mount SMA Connector
J3 - J4	DC Pin
C1, C2	Capacitor, 0402 Pkg.
C3	100 pF Capacitor, 0402 Pkg.
C4	1000 pF Capacitor, 0603 Pkg.
C5	2.2 $\mu$ F Capacitor, Tantalum
R1	Resistor, 1210 Pkg.
L1	Inductor, 0603 Pkg.
U1	HMC481MP86
PCB*	107087 Evaluation PCB
* Circuit Board Material: Rogers 4350	

The circuit board used in the final application should use RF circuit design techniques. Signal lines should have 50 ohm impedance while the package ground leads should be connected directly to the ground plane similar to that shown. A sufficient number of VIA holes should be used to connect the top and bottom ground planes. The evaluation board should be mounted to an appropriate heat sink. The evaluation circuit board shown is available from Hittite upon request.